



M&M Manufacturing Company

www.mmmfg.com

AUSTIN
(512)-960-2370

DALLAS
(972)-485-1504

FORT WORTH
(Adolph)
(817)-334-0034

FORT WORTH
(MKIV)
(817)-336-2311

HOUSTON
(713)-690-0585

LITTLE ROCK
(501)-888-3042

PROPRIETARY INFORMATION

THIS DRAWING AND/OR DATA SHEET, AND THE CONFIDENTIAL PROPRIETARY INFORMATION THEREON, ARE THE PROPERTY OF M&M MANUFACTURING, INC. AND ARE NOT TO BE REPRODUCED OR COPIED IN WHOLE OR IN PART, OR USED FOR UNAUTHORIZED MANUFACTURING OR ANY OTHER EXPLOITATION OF THE ITEM DISCLOSED THEREIN, OR IN ANY OTHER WAY DISCLOSED OR USED FOR FURNISHING INFORMATION.

0/12 Pitch

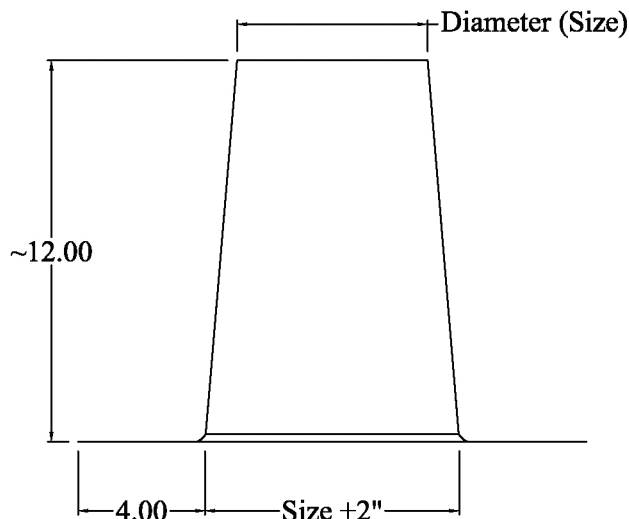
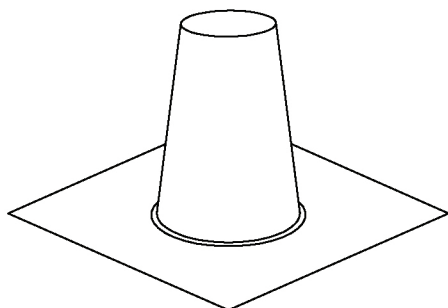

3/12 through 7/12 Pitch

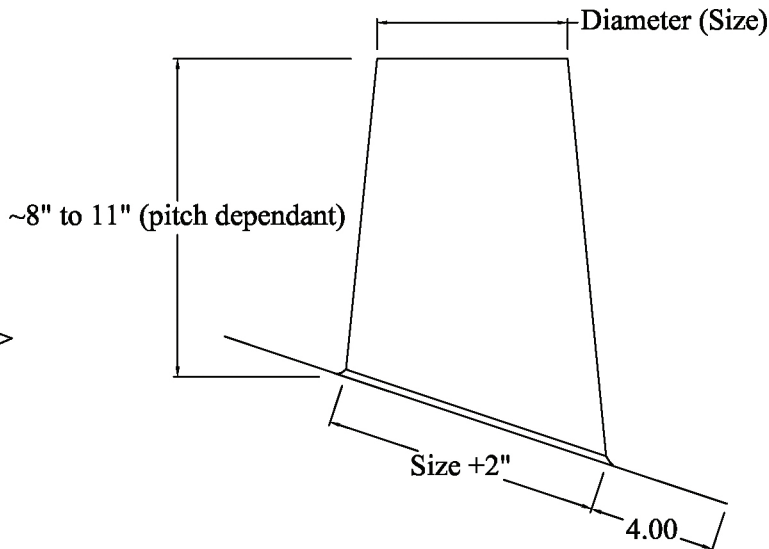
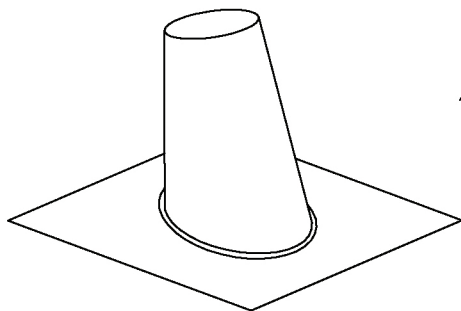

PART #: R-RJTNC(Size)?/12 **DESCRIPTION:** Standard pitch tapered roof jack

NOTES: Material: 26 gauge G-60 minimum
ASTM-A653 CS B galvanized steel

Upper diameter determines size

Sizes 7" through 9", 0/12 through 7/12 available

0/12 pitch roof jacks with spot welded and soldered stack to flashing joint

3/12 - 7/12 pitch roof jacks with spot welded and silicone sealed stack to flashing joint

Order as Pt# R-RJTNC(Size)?/12

Substitute ? with rise in inches over 12" run